

8100, 8300 SERIES

Pneumatic Swing Clamps | Product Overview

Features:

- Lightweight and robust, designed for several millions cycles
- Block style body may be mounted from the side or the top.
- Sensor ready for use with round style sensors
- Clamp arm and spindle included

Applications:

- Assembly
- Welding
- Light machining

Also Available:

See page MC-PSC-22 for clamping arms

See page MC-PSC-40 for sensing options

8115
Right-hand
Swing



8116
Left-hand
Swing



8315
Right-hand
Swing



8316
Left-hand
Swing



Technical Information

Model	Swing Direction	Total Stroke [in]mm	Stroke During Rotation [in]mm	Vertical Clamp Stroke [in]mm	Clamping Force [lbf.] N†	Bore Size mm[in]	Air Consumption‡ [ft³]dm³	Weight [lb.]kg	Replacement Seal Kit
8115	RH	[0.85]	[0.47]	[0.38]	[25]	[18]	[0.002]	[0.68]	801560
8116	LH	21,5	11,8	9,7	110	80	0,06	0,31	
8315	RH	[1.25]	[0.75]	[0.50]	[89]	[67]	[0.014]	[2.00]	821560
8316	LH	31,8	19,1	12,7	400	298	0,40	0,91	

† with standard clamping arm at 5bar [72psi]. ‡ per double stroke at 5bar [72psi]

Operating Pressure Range: 3bar [45psig] to 9bar [130psig]

Maximum Operating Temperature: -18°C to 60°C [0°F to 140°F]

Note:

To order without clamping arm add **-LA** to the end of the model. Ex. 8315-**LA**



8100, 8300 SERIES

Pneumatic Swing Clamps | Dimensions



Unclamped



Clamped

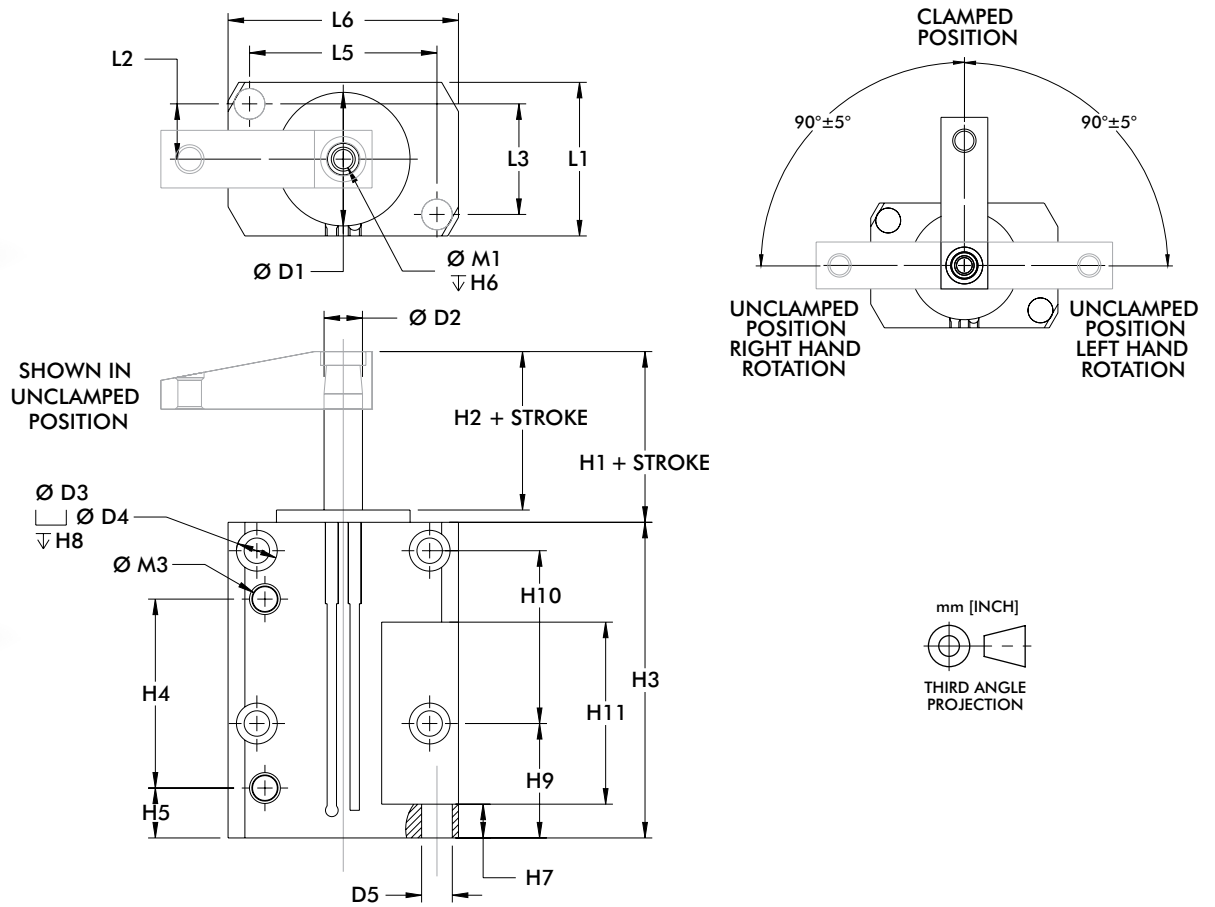

Model	ØD1	ØD2	ØD3	ØD4	ØD5	Stroke	H1	H2	H3	H4	H5	H6
8115	[1.23]	[0.44]	[0.20]	--	--	[0.85]	[0.53]	[0.41]	[3.37]	[1.45]	[0.35]	[0.75]
8116	31,2	11,2	5,1	--	--	21,5	13,5	10,4	85,6	36,8	8,9	19,1
8315	[1.74]	[0.50]	[0.33]	[0.53]	[0.40]	[1.25]	[0.97]	[0.81]	[4.11]	[2.46]	[0.65]	[0.67]
8316	44,2	12,7	8,4	13,5	10,2	31,8	24,6	20,6	104,4	62,5	16,5	17

Model	H7	H8	H9	H10	H11	L1	L2	L3	L5	L6	M1	M3
8115	[0.25]	--	[1.37]	[1.00]	[1.00]	[1.25]	[0.47]	[0.94]	[0.94]	[1.25]	¼-20	#10-32
8116	6,4	--	34,8	25,4	25,4	31,8	11,9	23,9	23,9	31,8		
8315	[0.44]	[1.00]	[1.49]	[2.25]	[2.37]	[2.00]	[0.72]	[1.44]	[2.44]	[3.00]	5/16/18	1/8 NPT
8316	11,2	25,4	37,9	57,2	60,2	50,8	18,3	36,6	62	76,2		

Mounting Options

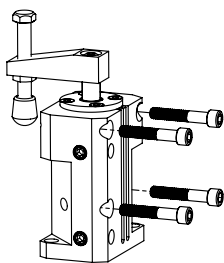

Can be mounted to the side or front of the fixture, or mounted back to back for multiple clamping operations.

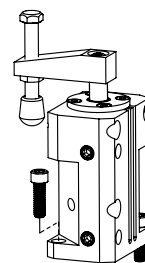

Mounted to the top of the work surface through the two mounting holes in the bottom of unit.

8100, 8300 SERIES

Pneumatic Swing Clamps | Clamping Forces

Series 8100, 8300 Clamping Force
(w/ standard clamping arm)

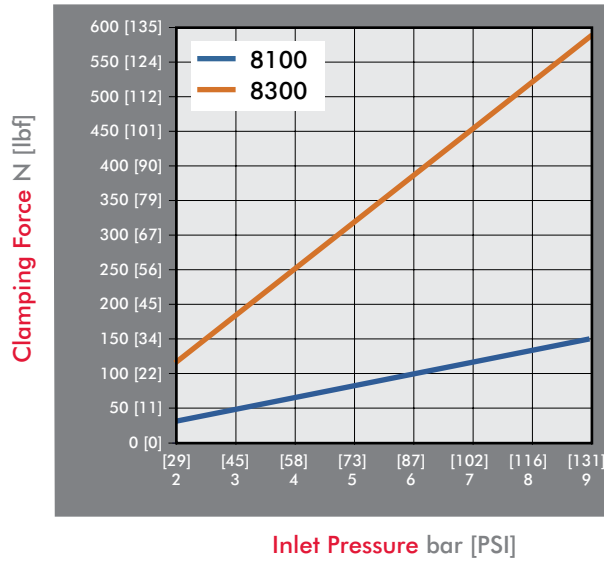

Guidelines

DESTACO Pneumatic Swing Clamps are designed for long life when using standard clamping arms and spindles. In the event that a longer arm or additional weight is needed, please consult these charts for the allowable weight and length.

Example: 8315

At a weight of 80 gr, the maximum length of the arm is approximately 90mm.

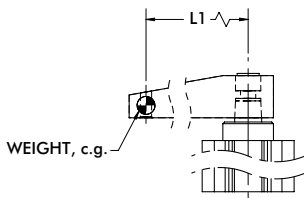

All data refers to an operating pressure of 5 bar [72psi] and an opening and closing time of 1 second.

8115/8116 Clamp Arm Weight

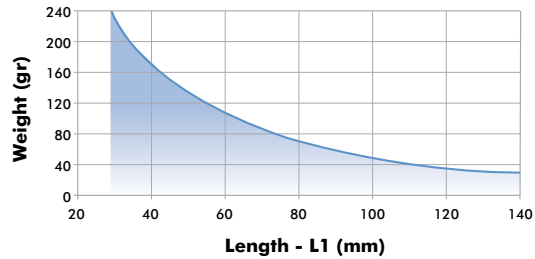

8315/8316 Clamp Arm Weight

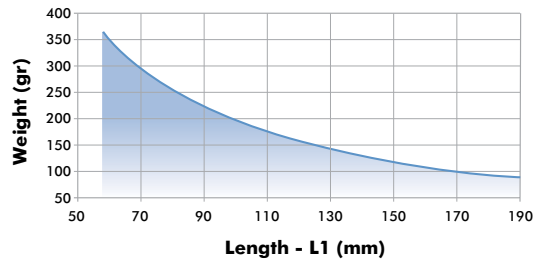

8100, 8300 SERIES

Pneumatic Swing Clamps | Clamping Arms

Features:

- Lightweight aluminum construction
- Locking tapered connection for 360 deg. arm positioning

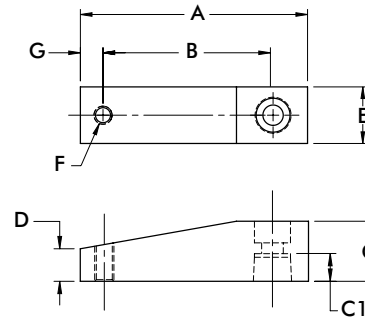
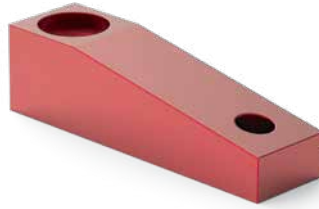

Part Number	Used with Model	A	B	C	C1	D	E	F	G	Weight [lbs] kg
801528	8115, 8116	[1.74] 44,2	[1.11] 28,2	[0.37] 9,4	[0.33] 8,3	[0.25] 6,4	[0.62] 15,7	#10-32	[0.32] 8,1	[0.03] 0,01
801529		[2.87] 72,9	[2.24] 56,9							
821512	8315, 8316	[2.75] 69,9	[2.00] 50,8	[0.75] 19,1	[0.57] 14,5	[0.38] 9,5	[0.75] 19,1	3/8-16	[0.38] 9,5	[0.05] 0,02
821513		[3.75] 95,3	[3.00] 76,2							

Clamping Arm Adapters

Features:

- For attaching custom made clamp arms
- 360° rotatable arm
- Aluminum construction

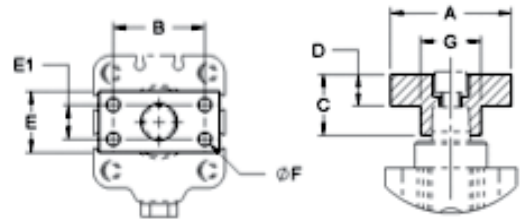
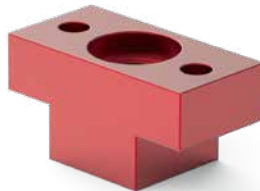

Part Number	Used with Model	A	B	C	D	E	E1	F	Weight [lbs] kg
801532	8115, 8116	[1.37] 34,8	[1.00] 25,4	[0.39] 9,1	[0.25] 6,4	[0.62] 15,7	--	#10-32 (2x)	[0.03] 0,014
821556	8315, 8316	[1.50] 38,1	[1.06] 26,9	[0.75] 19	[0.37] 9,4	[0.75] 19	--	1/4-20 (2x)	[0.05] 0,020