

## Shrink discs

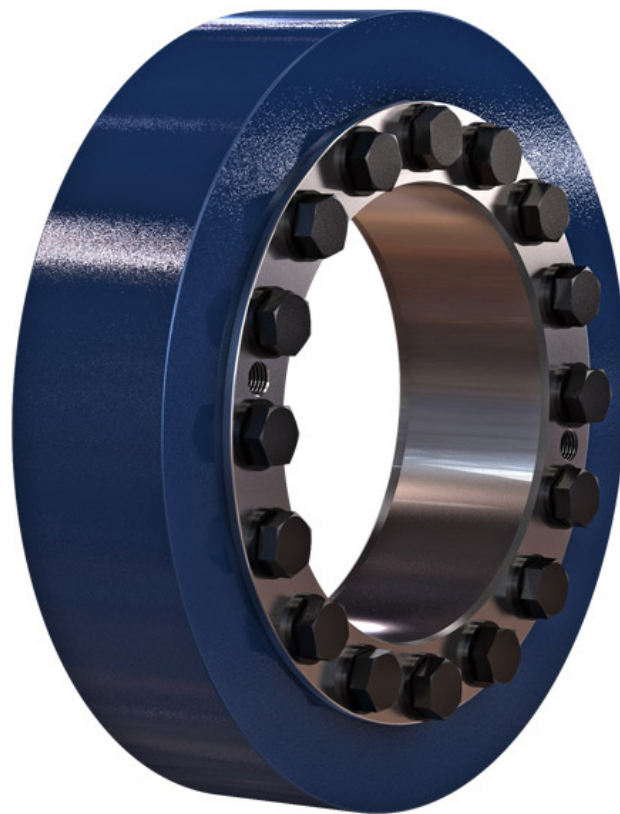

2-part shrink discs  
(torque-controlled)

# Description of function

## Two part shrink disc of the types TAS 31..

The main function of a shrink disc is the safe connection of a shaft with a hub by means of friction. For example, between a drive shaft and a transmission hollow shaft. The shrink disc generates a backlash-free connection by pressing the hub onto the shaft. This connection is mainly used to transmit torque.

The shrink disc only provides the required forces, and transfers no forces or moments between shaft and hub by itself. Therefore, the force flow does not pass through it.

It is installed by sliding the shrink disc onto the hollow shaft and the subsequent tightening of the screws. By using conical surfaces the inner diameter reduces and the radial pressure is built up. The 31xx range of shrink discs are self-locking. The clamping forces are provided and controlled through the screws (force controlled). This allows the direct compensation of the clearance between the shaft and hub, without an overload that may occur on path controlled shrink discs, due to small or over sized clearance. Except

for this are the shrink disks of the type 3173 as well as the types 3191 and 3193 to d 185mm. They are controlled by path (front faces are flush).

The supplied shrink discs are ready for installation.

To achieve proper operation with a sufficiently high coefficient of friction, the contact surfaces between shaft and hub must be dry, clean and free of grease. The functional surfaces of the shrink disc, the thread and head rests of the screws, are equipped at the factory with lubricant. Molykote G-Rapid Plus or comparable must be used as a lubricant. The contact surfaces between the hub and the bush must be provided with grease or oil before installation.

### Product data

A detailed installation manual is available on our Homepage.

Data sheets  
Contact us if a data sheet for an individual product is required.

Desired product is not available, please contact us directly.

CAD data  
We provide CAD data for our products in various formats. Please contact:

**Rolf Gertner**  
rolf.gertner@tas-schaefer.de

or

**Mike Kemper**  
mike.kemper@tas-schaefer.de

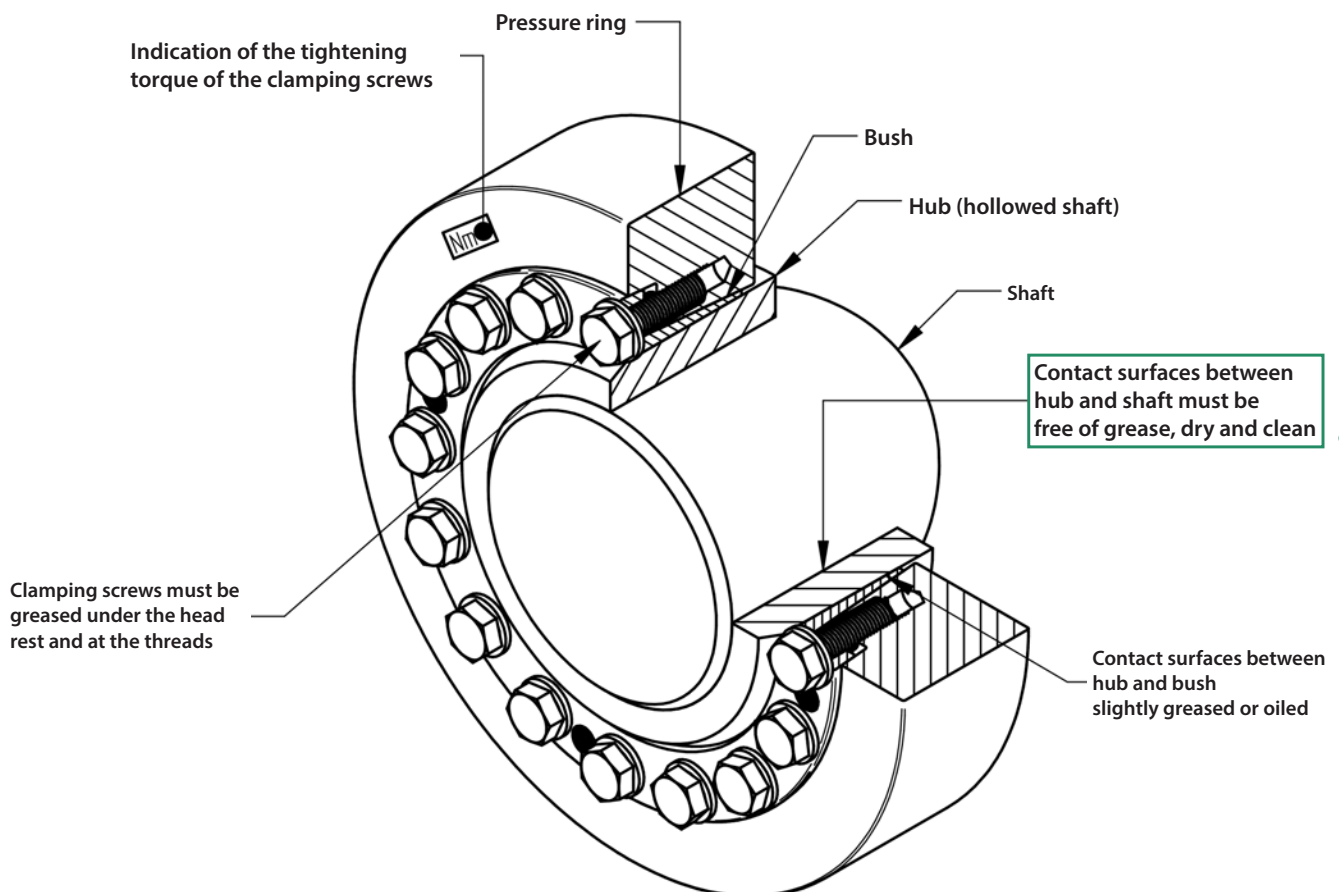

# Basics - Design

## Clamping length for shrink discs

The clamping length  $l$  of the shrink disk at the junction  $l_k$  (between shaft and hub), should be chosen to be somewhat wider to minimize the stress concentration at this point. An excessively wide connection increases the tendency to fretting corrosion, because the pressure decreases outward. The pressure is distributed approximately at an angle between  $15^\circ - 20^\circ$  through the hub. This is largely dependent on the hub wall thickness and stiffness of the shaft. A good approximation can be made from the following equation:

Clamping length of the contact area:  
 $l_k = 0,316(d - d_w) + l$

The cylindrical surfaces should be located symmetrically under the shrink disc! With a slightly different clamping length the transmissible torque  $M$  will not change, because a smaller contact surface results in a higher pressure - ergo a larger contact surface causes lower pressure.

## Tightening torque of the clamping screws

The given tightening torque values in the tables for the screws are based on a friction coefficient  $\mu_{ges} = 0,1$ . In principle, the specified tightening torque  $M_A$  can be reduced to  $M_{Agew}$  to reduce stresses in the components. This may be necessary for soft materials and bored shafts. The reduction of  $M_A$  also reduced the pressure  $p_N$  and transmissible torque  $M$ . The ratio is approximately proportional and can be calculated according to:

$$M = \frac{M_{Agew}}{M_A} M \quad \text{also} \quad p_N = \frac{M_{Agew}}{M_A} p_N$$

The tightening torques can not be reduced arbitrary, therefore apply the following limits:

$$M_{Agew} \geq \begin{matrix} \text{Class 8.8: } 0,85 M_A \\ \text{Class 10.9: } 0,70 M_A \\ \text{Class 12.9: } 0,60 M_A \end{matrix} \leq M_A$$

A further reduction requires additional screw locks!

The values found in the product data based on surface quality and tolerances according to the table below. These values are given as recommendations.

Higher values for the surface roughness reduces the transmissible torque and promote unwanted settling. Larger clearance also reduces the transmissible torque and heightened tensions in the hub.

**In the case of significantly different values, please contact us!**

**Tolerance for the outer diameter hub - f7!**

Recommended tolerances and surface roughness

>	≤	FS <sub>max</sub> mm	Clearance Hub/Shaft	Rz µm
9	18	0,022	H6/h6	10
18	30	0,026	H6/h6	10
30	50	0,032	H6/h6	10
50	80	0,049	H7/h6	10
80	120	0,057	H7/h6	16
120	150	0,065	H7/h6	16
150	180	0,079	H7/g6	16
180	250	0,090	H7/g6	16
250	315	0,101	H7/g6	16
315	400	0,111	H7/g6	16
400	500	0,123	H7/g6	25
500	630	0,136	H7/g6	25
630	800	0,154	H7/g6	25
800	1000	0,172	H7/g6	25

# Basics - Calculation

The calculation of the values, given in the catalogue, are based on the following assumptions and simplifications:

## Transmissible torque

A shrink disc connection is capable of transmitting torque, bending moment and axial force. Alternatively, the transmissible torque  $M_{\max}$  is specified in the product data. If such loads occur simultaneously then they must be added vectorially to the resultant moment  $M_{\text{res}}$ .

The formula below applies to the resulting moment:

$$M_{\text{res}} \leq M_{\max}$$

At different load cases, these are individually checked against  $M_{\max}$ !  $M_{\text{res}}$  is determined for combined loads as follows:

$$M_{\text{res}} = \sqrt{M_T^2 + 2M_B^2 + (F_{\text{AX}} \frac{d_W}{2})^2}$$

$$\text{with } M_B \leq 0,3 M_{\max}$$

as the limit\* for the the bending moment

\*In principle, the maximum bending moment corresponds to the maximum transmittable torque. The limitation to 0,3  $M_{\max}$  is due to the change of the surface pressure at the edges of the connection. (see also „Bending moment“)

This results in the following relationships:

### Torque only:

The maximum torque is equivalent to  $M_{\max}$

### Bending moment only:

The maximum bending moment corresponds to 0,3  $M_{\max}$ .

### Axial force only:

The maximum axial force is

$$M_{\max} \frac{2}{d_W}$$

A different equation applies for very small shrink discs (3073):

$$M_B \leq 0,2 M_{\max}$$

Depending on the application, additional safety factors need to be considered for the individual loads!

## Calculation of transmissible torques and forces

The catalogue data relates to specific shaft diameters which we recommend using. If the shaft diameter is between two sizes, the larger shrink disc should be selected. A deviation is possible within certain limits but the predetermined tolerances and surface roughness should be considered.

The shaft diameter and transmissible torque behave approximately proportional to each other. The transmissible torque increases with greater shaft diameter and vice versa. In contrast, the transmissible axial force changes only slightly. This is not due to the shaft diameter but because of the change in stiffness of the hub when the inner diameter changes.

Within certain limits, the changes can be linearly approximated. Information about the range of the respective shaft diameter can be found in the product data. The determination of the deviating values is explained below. Please contact us if the shaft diameter must be outside the indicated range. The formula below calculates the torque for specific shaft diameters:

$$M = M_{\max (Catalog)} \left( \frac{d_W (target)}{d_W (Catalog)} \right)^2$$

The corresponding axial force which is transmitted instead of the torque, results as follows:

$$F_{\text{ax}} = M \frac{2}{d_W (table)}$$

## Radial force

Radial forces cause a change in pressure at the contact surface. In the force direction, the pressure increases on the one side and is reduced accordingly on the other side. This depends on the amount of radial force and the rigidity of the parts.

The following equation can be used to approximate the pressure change:

$$\Delta p_W = 0,75 \frac{F_{\text{AX}}}{d_W l_K}$$

The modified pressures  $p_{W_{\min, \max}}$  results from the following equation:

$$p_{W_{\min, \max}} = p_W \pm \Delta p_W$$

The minimum pressure  $p_{W_{\min}}$  should be at least 50 N/mm<sup>2</sup> to avoid gap corrosion. In addition, the material must be designed for a maximum pressure  $p_{W_{\max}}$ .

# Basics - Calculation

The calculation of the values, given in the catalogue, are based on the following assumptions and simplifications:

## Bending moment

Here the situation is similar to the radial forces. However the pressure is greatest at the ends of the connection in this case. Again, the amount and stiffness are important. This leads to the following approximation:

$$\Delta p_W = 4,5 \frac{M_B}{d_W l_K^2}$$

As before, the modified pressures results from:

$$p_{Wmin, max} = p_W \pm \Delta p_W$$

The conditions for minimum and maximum pressure are the same as before. It should be noted that there could be a change in pressure due to radial force!

The information on the minimum yield strength of shafts and hubs are suggested recommendations, based on typical values for such applications. They are provided as guidelines and are not a replacement for a proper calculation for a given application!

## Notch effect

Generally there is a notch effect on the components, caused by the radial pressure of the shrink disc. This depends mainly on the applied pressure. The notch effect is generally higher on the hub than on the shaft, because here the inner ring of the shrink disc is directly pressed onto the hub, while the stresses are distributed through the hub before reaching the shaft. The notch factors range from 2,5 to 3,5 for the hub and it is between 1,5 and 2 for the shaft. This can be mitigated by suitable design features, such as relief notches.

Some standards provide the possibility of a notch factor to be determined by a fit pairing for a shrink-connection. A similar method also can be used for a shrink disc connection. To this end an oversize can be calculated from the applied surface pressures. As a result, a matching fit pair can be determine and thus a resultant notch factor found.

## Bore in the shaft (hollow shaft)

A large bore  $d_B$  in the shaft or the use of a hollow shaft, reduces the stiffness of this component against radial pressure. This leads to a decrease in pressure  $p_W$ , a reduced transmissible torque  $M$ , a contraction  $\Delta B$  within the shaft and an increase of stresses in these components. Basically, a bore should not be greater than 0,3  $d_W$ .

## Shaft and hub calculation

The catalogue contains information on the generated surface pressure for each shrink disc. The hub will be deformed due to the applied radial force. In addition to the clearance between shaft and hub, shaft stiffness and surface finish should be considered. For solid shafts the flexibility can be ignored, but with hollow shafts (see „Bore in the shaft (hollow shaft)“) there is greater deformation and thus greater stresses in the components. This must be considered in addition to other loads.

The stresses in the hub can be determined by various hypotheses, such as GEH. We will not make a presentation and analyse results at this point because we would only be able to cover a very limited range of static applications. Various calculation methods for different cases can be found in engineering literature or using specialised software. However, for complex geometry often only a calculation by FEM gives reliable results.

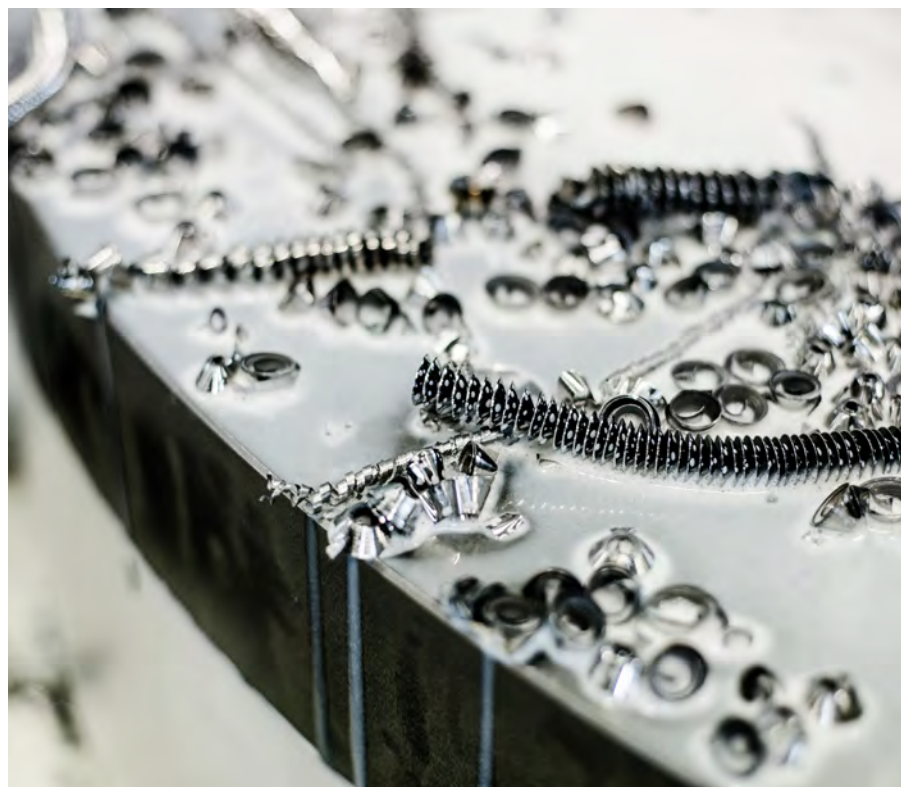





**TAS**  
**SCHÄFER**



# 3171 Standard-Range

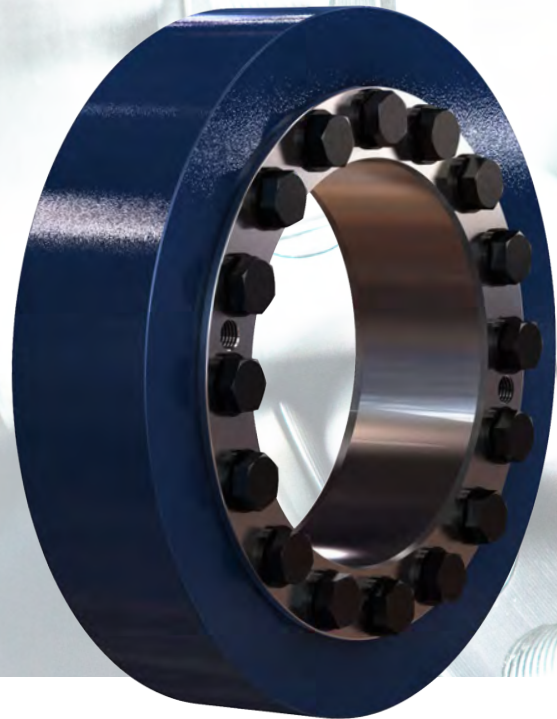
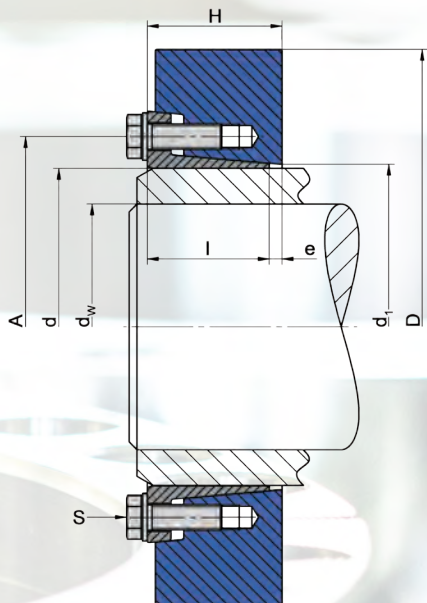

## Used symbols

d	[mm]	Nominal diameter of the shrink disc
$d_w$	[mm]	Shaft diameter
$M_{max}$	[mm]	Maximal transmittable torque
D	[mm]	Outer diameter
l	[mm]	Length of the bush
e	[mm]	Excess length
H	[mm]	Width of the shrink disc
A	[mm]	Pitch circle diameter
$d_1$	[mm]	Attachment size
$M_A$	[Nm]	Tightening torque of the clamping screws
Z		Number of clamping screws
S		Size of the clamping screws
$n_{max}$	[min <sup>-1</sup> ]	Permitted rotational frequency
$p_N$	[N/mm <sup>2</sup> ]	Average Pressure to the hub
I	[kgm <sup>2</sup> ]	Moment of inertia

## Design of the shrink disc

$d < 120$	Discs lightly oiled without washers
$d \geq 120$	Discs painted with washers
$d \geq 195$	Cone of bush not slit

Dimensions H & e in unlocked position

min. yield strength Rp0,2	N/mm <sup>2</sup>
Solid shaft	290
hub	350

## Variation from the standard shaft diameter $d_w$

> mm	≤ mm	minimal - mm	maximal + mm
10	30	-1	1
30	50	-3	2
50	140	-5	5
140	180	-10	5
180	320	-15	10
320	500	-20	10
500	700	-30	20

$$M = M_{max(Catalog)} \left( \frac{d_w(target)}{d_w(Catalog)} \right)^2$$

(see Basics - Calculation)

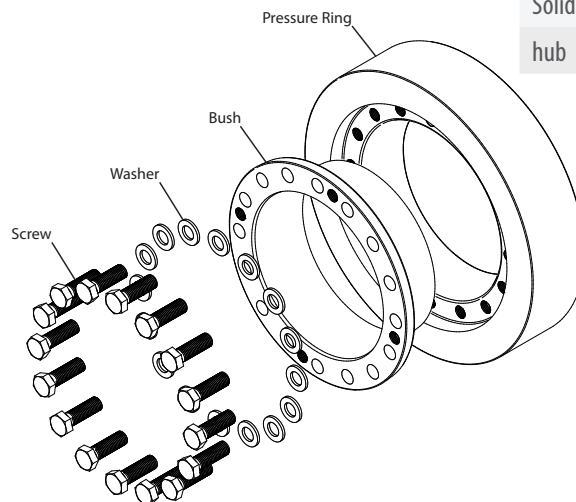

Ordering information: TAS 3171-d (z.B.: TAS 3171-200 ... further sizes on request)

# 3171 Standard-Range

<b>d</b> mm	<b>d<sub>w</sub></b> mm	<b>M<sub>max</sub></b> Nm	<b>D</b> mm	<b>l</b> mm	<b>e</b> mm	<b>H</b> mm	<b>A</b> mm	<b>d<sub>1</sub></b> mm	<b>M<sub>A</sub></b> Nm	<b>Z</b> Stk	<b>S</b>	<b>DIN</b>	<b>Class</b>	<b>n<sub>max</sub></b> min <sup>-1</sup>	<b>p<sub>N</sub></b> N/mm <sup>2</sup>	<b>I</b> kgm <sup>2</sup>	<b>Weight</b> kg
14	11	36	38	10	1	11	26	15	12	3	M 6 x 10	933	10.9	15078	386	0,0000154	0,08
16	13	75	41	13,5	1,5	15	28	17	12	3	M 6 x 12	933	10.9	13975	431	0,0000285	0,12
18	15	100	44	13,5	1,5	15	30	19	12	3	M 6 x 12	933	10.9	13022	389	0,0000376	0,13
20	17	150	47	13,5	1,5	15	32	22	12	3	M 6 x 12	933	10.9	12191	342	0,0000488	0,15
24	20	215	50	16	2	18	36	26	12	4	M 6 x 16	933	10.9	11459	329	0,0000734	0,19
30	25	430	60	18	2	20	44	32	12	6	M 6 x 16	933	10.9	9549	341	0,0001689	0,30
36	30	740	72	20	2	22	52	38	30	5	M 8 x 20	933	10.9	7958	483	0,0003786	0,47
38	32	760	72	20	2	22	53	40	30	5	M 8 x 20	933	10.9	7958	460	0,0003725	0,45
44	35	790	80	22	2	24	61	47	30	5	M 8 x 20	933	10.9	7162	341	0,0006151	0,59
50	40	1370	90	23,5	2,5	26	68	53	30	7	M 8 x 20	933	10.9	6366	386	0,0010705	0,81
55	45	1840	100	26	3	29	72	58	30	8	M 8 x 20	933	10.9	5730	360	0,0018431	1,13
62	50	1990	110	26	3	29	80	66	30	8	M 8 x 20	933	10.9	5209	318	0,0026706	1,34
68	55	2460	115	26	3	29	86	72	30	9	M 8 x 20	933	10.9	4982	329	0,0031146	1,40
75	60	3830	138	27	4	31	100	79	59	8	M 10 x 25	933	10.9	4152	424	0,0070393	2,28
80	65	4240	138	27	4	31	104	84	59	8	M 10 x 25	933	10.9	4152	399	0,0068412	2,15
85	68	6000	155	34	4	38	114	94	59	10	M 10 x 30	933	10.9	3697	338	0,0138071	3,53
90	70	5830	155	34	4	38	114	94	59	10	M 10 x 30	933	10.9	3697	338	0,0134544	3,35
100	75	7400	170	39	4	43	124	104	59	12	M 10 x 30	933	10.9	3370	305	0,0220976	4,54
105	80	10000	185	44	5	49	136	114	100	10	M 12 x 30	933	10.9	3097	308	0,0362860	6,42
110	85	11700	185	44	5	49	136	114	100	10	M 12 x 30	933	10.9	3097	308	0,0354267	6,12
125	95	14900	215	47,5	5,5	53	160	134	100	12	M 12 x 35	933	10.9	2665	284	0,0703948	9,11
130	100	19600	215	47,5	5,5	53	160	134	100	12	M 12 x 35	933	10.9	2665	284	0,0688524	8,73
135	100	20400	230	52	6	58	173	145	160	10	M 14 x 40	933	10.9	2491	284	0,1009972	11,4
140	105	19000	230	52	6	58	173	145	160	10	M 14 x 40	933	10.9	2491	284	0,0988674	10,9
150	110	26400	263	56	6	62	190	164	160	12	M 14 x 40	933	10.9	2179	274	0,1864460	16,3
155	115	27200	263	56	6	62	190	164	160	12	M 14 x 40	933	10.9	2179	274	0,1833539	15,7
160	120	32000	263	56	6	62	190	164	160	12	M 14 x 40	933	10.9	2179	274	0,1799476	15,2
165	125	38200	290	61	7	68	204	175	250	10	M 16 x 45	933	10.9	1976	297	0,3044866	21,9
175	135	46000	300	60	8	68	214	185	250	12	M 16 x 50	933	10.9	1910	345	0,3444253	22,8
185	145	66700	330	77	8	85	226	194	250	14	M 16 x 50	933	10.9	1736	278	0,6464885	36,1
195	150	82000	350	77	8	85	240	205	250	16	M 16 x 50	933	10.9	1637	300	0,8151453	40,6
200	155	83600	350	77	8	85	240	205	250	16	M 16 x 50	933	10.9	1637	300	0,8058820	39,7
220	165	109000	370	94	10	104	270	226	490	16	M 20 x 60	933	10.9	1549	342	1,2075884	52,1
240	180	140000	405	97	10	107	296	246	490	18	M 20 x 60	933	10.9	1415	342	1,8077432	65,3
260	200	184000	430	109	10	119	318	266	490	21	M 20 x 60	933	10.9	1332	319	2,5259772	80,0
280	220	240000	460	124	10	134	340	287	490	22	M 20 x 60	933	10.9	1246	269	3,6716977	101
300	230	300000	485	132	10	142	360	307	840	20	M 24 x 70	933	10.9	1181	323	4,7555885	117
320	250	332000	520	133	10	143	380	327	840	21	M 24 x 70	933	10.9	1102	319	6,2826175	135
340	260	427000	570	146	12	158	402	348	840	22	M 24 x 80	931	10.9	1005	278	10,2530016	186
360	280	539000	590	150	12	162	424	368	840	24	M 24 x 80	931	10.9	971	278	11,9213225	200
380	290	536000	635	149	14	163	448	388	1250	18	M 27 x 80	933	10.9	902	258	16,5612857	242
390	300	561000	650	152	14	166	458	398	1250	18	M 27 x 80	933	10.9	881	252	18,1541897	253



# 3171 Standard-Range

$d$ mm	$d_w$ mm	$M_{max}$ Nm	$D$ mm	$l$ mm	$e$ mm	$H$ mm	$A$ mm	$d_1$ mm	$M_A$ Nm	$Z$ Stk	$S$	$DIN$	$Class$	$n_{max}$ min <sup>-1</sup>	$p_N$ N/mm <sup>2</sup>	$I$ kgm <sup>2</sup>	$Weight$ kg
400	310	648000	660	158	15	173	475	410	1250	20	M 27 x 80	931	10.9	868	255	20,3512933	273
420	330	731300	690	171	15	186	495	430	1250	21	M 27 x 80	931	10.9	830	236	25,7145823	315
440	350	912000	740	181	15	196	516	448	1250	24	M 27 x 80	931	10.9	774	243	36,3755200	393
460	370	1026000	770	181	15	196	536	468	1250	25	M 27 x 80	933	10.9	744	243	42,5268672	423
480	390	1177000	800	201	15	216	556	488	1250	27	M 27 x 80	933	10.9	716	223	54,3812311	500
500	410	1288000	850	201	15	216	580	510	1250	28	M 27 x 80	933	10.9	674	222	70,0908985	577
530	440	1660000	910	223	15	238	616	538	1700	27	M 30 x 90	931	10.9	630	219	102,5969192	740
560	460	2083000	940	223	22	245	646	568	1700	28	M 30 x 90	931	10.9	610	250	115,3714200	771
590	480	2140000	950	240	23	263	670	598	1700	28	M 30 x 100	931	10.9	597	219	126,5966100	810
620	510	2560000	970	268	23	291	716	630	1700	28	M 30 x 100	931	10.9	562	206	149,6295300	904
640	530	2372000	970	269	18	287	736	650	1700	28	M 30 x 100	931	10.9	562	178	145,5701500	862
660	550	2830000	1020	270	22	292	770	670	2200	28	M 33 x 110	931	10.9	535	195	182,4488800	989





# TAS SCHÄFER

## FRICITION SPRING RELIABILITY MAKES THE DIFFERENCE

- High spring energy with low weight and volume
- High damping
- Overload secure in block setting
- Independent of the loading rate
- Maintenance - free
- Variable construction of the friction spring



**TAS Schäfer GmbH**

Osterfeldstrasse 75  
58300 Wetter

Telefon: +49 (0) 2335 9781-0

Fax: +49 (0) 2335 72956

[www.tas-schaefer.de](http://www.tas-schaefer.de)  
[info@tas-schaefer.de](mailto:info@tas-schaefer.de)





# 3181 Standard-Range (strengthened)

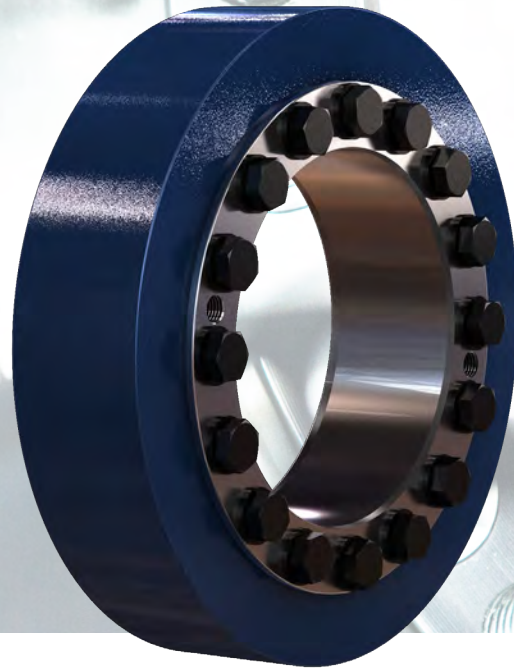
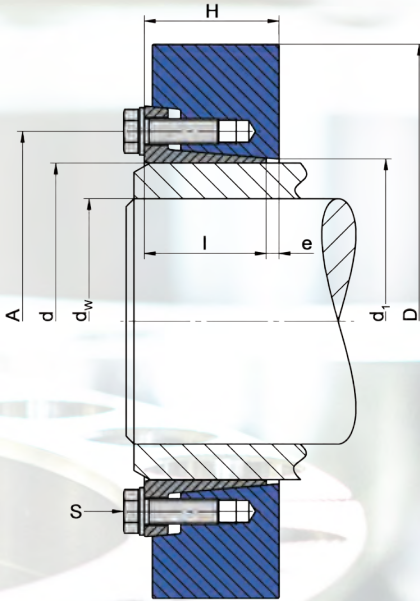

## Used symbols

d	[mm]	Nominal diameter of the shrink disc
d <sub>w</sub>	[mm]	Shaft diameter
M <sub>max</sub>	[mm]	Maximal transmittable torque
D	[mm]	Outer diameter
l	[mm]	Length of the bush
e	[mm]	Excess length
H	[mm]	Width of the shrink disc
A	[mm]	Pitch circle diameter
d <sub>1</sub>	[mm]	Attachment size
M <sub>A</sub>	[Nm]	Tightening torque of the clamping screws
Z		Number of clamping screws
S		Size of the clamping screws
n <sub>max</sub>	[min-1]	Permitted rotational frequency
p <sub>N</sub>	[N/mm <sup>2</sup> ]	Average pressure to the hub
I	[kgm <sup>2</sup> ]	Moment of inertia

## Design of the shrink disc

d < 120	Discs lightly oiled without washers
d ≥ 120	Discs painted with washers
d ≥ 195	Cone of bush not slit

Dimensions H & e in unlocked position

min. yield strength Rp0,2	N/mm <sup>2</sup>
Solid shaft	350
Hub	450

## Variation from the standard shaft diameter d<sub>w</sub>

> mm	≤ mm	minimal - mm	maximal + mm
10	30	-1	1
30	50	-3	2
50	140	-5	5
140	180	-10	5
180	320	-15	10
320	500	-20	10
500	700	-30	20

$$M = M_{\max(\text{Catalog})} \left( \frac{d_{w(\text{target})}}{d_{w(\text{Catalog})}} \right)^2$$

(see Basics - Calculation)

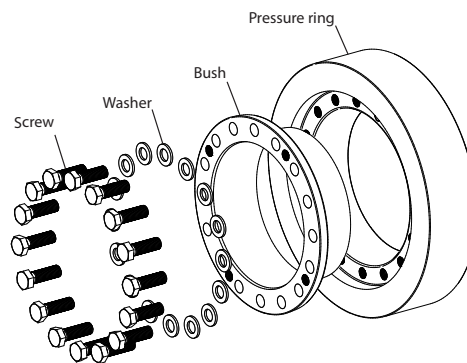

Ordering information: TAS 3181 - d (z.B.: TAS 3181-200 ... further sizes on request)



# 3181 Standard-Range (strengthened)

<b>d</b> mm	<b>d<sub>w</sub></b> mm	<b>M<sub>max</sub></b> Nm	<b>D</b> mm	<b>l</b> mm	<b>e</b> mm	<b>H</b> mm	<b>A</b> mm	<b>d<sub>1</sub></b> mm	<b>M<sub>A</sub></b> Nm	<b>Z</b> Stk	<b>S</b>	<b>DIN</b>	<b>Klasse</b>	<b>n<sub>max</sub></b> min <sup>-1</sup>	<b>p<sub>N</sub></b> N/mm <sup>2</sup>	<b>I</b> kgm <sup>2</sup>	<b>Weight</b> kg
24	20	275	50	16	2	18	36	26	14	4	M 6 x 16	933	12.9	11459	387	0,0000734	0,19
30	25	570	60	18	2	20	44	32	14	6	M 6 x 16	933	12.9	9549	400	0,0001689	0,30
36	30	880	72	20	2	22	52	38	35	5	M 8 x 20	933	12.9	7958	564	0,0003786	0,47
38	32	910	72	20	2	22	53	40	35	5	M 8 x 20	933	12.9	7958	536	0,0003725	0,45
44	35	960	80	22	2	24	61	47	35	5	M 8 x 20	933	12.9	7162	398	0,0006151	0,59
50	40	1700	90	23,5	2,5	26	68	53	35	7	M 8 x 20	933	12.9	6366	451	0,0010705	0,81
55	45	2000	99,3	26	3	29	72	58	35	6	M 8 x 20	933	12.9	5770	316	0,0017869	1,11
62	50	2400	110	26	3	29	80	66	35	8	M 8 x 20	933	12.9	5209	371	0,0026706	1,34
68	55	3000	115	26	3	29	86	72	35	9	M 8 x 20	933	12.9	4982	384	0,0031146	1,40
75	60	4600	138	27	4	31	100	79	69	8	M 10 x 25	933	12.9	4152	496	0,0070393	2,28
80	65	5200	138	27	4	31	104	84	69	8	M 10 x 25	933	12.9	4152	467	0,0068412	2,15
85	68	6700	155	34	4	38	114	94	69	10	M 10 x 30	933	12.9	3697	396	0,0138071	3,53
90	70	7100	155	34	4	38	114	94	69	10	M 10 x 30	933	12.9	3697	396	0,0134544	3,35
100	75	8800	170	39	4	43	124	104	69	12	M 10 x 30	933	12.9	3370	357	0,0220976	4,54
105	80	12600	185	44	5	49	136	114	120	10	M 12 x 30	933	12.9	3097	360	0,0362860	6,42
110	85	14600	185	44	5	49	136	114	120	10	M 12 x 30	933	12.9	3097	360	0,0354267	6,12
125	95	18700	215	47,5	5,5	53	160	134	120	12	M 12 x 35	933	12.9	2665	333	0,0703948	9,11
130	100	22900	215	47,5	5,5	53	160	134	120	12	M 12 x 35	933	12.9	2665	333	0,0688524	8,73
135	100	23400	230	52	6	58	173	145	190	10	M 14 x 40	933	12.9	2491	334	0,1009972	11,4
140	105	23500	230	52	6	58	173	145	190	10	M 14 x 40	933	12.9	2491	334	0,0988674	10,9
150	110	31300	263	56	6	62	190	164	190	12	M 14 x 40	933	12.9	2179	321	0,1864460	16,3
155	115	34200	263	56	6	62	190	164	190	12	M 14 x 40	933	12.9	2179	321	0,1833539	15,7
160	120	38300	263	56	6	62	190	164	190	12	M 14 x 40	933	12.9	2179	321	0,1799476	15,2
165	125	48300	290	61	7	68	204	175	290	10	M 16 x 45	933	12.9	1976	349	0,3044866	21,9
175	135	58200	300	60	8	68	214	185	290	12	M 16 x 50	933	12.9	1910	405	0,3444253	22,8
185	145	82000	330	77	8	85	224	194	290	14	M 16 x 50	933	12.9	1736	326	0,6464885	36,1
195	150	98200	350	77	8	85	240	205	290	16	M 16 x 50	933	12.9	1637	353	0,8151453	40,6
200	155	102000	350	77	8	85	240	205	290	16	M 16 x 50	933	12.9	1637	353	0,8058820	39,7
220	165	134000	370	94	10	104	270	226	570	16	M 20 x 60	933	12.9	1549	401	1,2075884	52,1
240	180	172000	405	97	10	107	296	246	570	18	M 20 x 60	933	12.9	1415	400	1,8077432	65,3
260	200	226000	430	109	10	119	318	266	570	21	M 20 x 60	933	12.9	1332	373	2,5259772	80,0
280	220	295000	460	124	10	134	340	287	570	22	M 20 x 60	933	12.9	1246	315	3,6716977	101
300	230	367000	485	132	10	142	360	307	980	20	M 24 x 70	933	12.9	1181	379	4,7555885	117
320	250	410000	520	133	10	143	380	327	980	21	M 24 x 70	933	12.9	1102	374	6,2826175	135
340	260	525000	570	146	12	158	402	348	980	22	M 24 x 80	931	12.9	1005	327	10,2530016	186
360	280	553000	590	150	12	162	424	368	980	21	M 24 x 80	931	12.9	971	285	11,9213225	200
380	290	636000	635	149	14	163	448	388	1450	18	M 27 x 80	933	12.9	902	303	16,5612857	242
390	300	666700	650	152	14	166	458	398	1450	18	M 27 x 80	933	12.9	881	296	18,1541897	253
400	310	769000	660	158	15	173	475	410	1450	20	M 27 x 80	931	12.9	868	299	20,3512933	273
420	330	868000	690	171	15	186	495	430	1450	21	M 27 x 80	931	12.9	830	278	25,7145823	315
440	350	1081000	740	181	15	196	516	448	1450	24	M 27 x 80	931	12.9	774	285	36,3755200	393
460	370	1214000	770	181	15	196	536	468	1450	25	M 27 x 80	933	12.9	744	285	42,5268672	423
480	390	1393000	800	201	15	216	556	488	1450	27	M 27 x 80	933	12.9	716	262	54,3812311	500
500	410	1525000	850	201	15	216	580	510	1450	28	M 27 x 80	933	12.9	674	260	70,0908985	577

# 3181 Standard-Range (strengthened)

<b>d</b> mm	<b>d<sub>w</sub></b> mm	<b>M<sub>max</sub></b> Nm	<b>D</b> mm	<b>l</b> mm	<b>e</b> mm	<b>H</b> mm	<b>A</b> mm	<b>d<sub>1</sub></b> mm	<b>M<sub>A</sub></b> Nm	<b>Z</b> Stk	<b>S</b>	<b>DIN</b>	<b>Klasse</b>	<b>n<sub>max</sub></b> min <sup>-1</sup>	<b>p<sub>N</sub></b> N/mm <sup>2</sup>	<b>I</b> kgm <sup>2</sup>	<b>Weight</b> kg
<b>530</b>	440	1960000	910	226	15	241	616	538	1950	27	M 30 x 90	931	12.9	630	257	102,5969192	740
<b>560</b>	460	2457000	940	223	22	245	646	568	1950	28	M 30 x 90	931	12.9	610	293	152,4393500	771
<b>590</b>	480	2524000	950	240	23	263	670	598	1950	28	M 30 x 100	931	12.9	597	257	160,4661900	810
<b>620</b>	510	3018000	970	268	28	296	716	630	1950	28	M 30 x 100	931	12.9	562	241	189,6250362	903
<b>640</b>	530	2805000	1020	269	18	287	736	650	1950	28	M 30 x 100	931	12.9	562	208	185,5656631	1024
<b>660</b>	550	3356000	1070	270	22	292	770	670	2600	28	M 33 x 110	931	12.9	535	230	229,1223900	1160



**We stand for  
Quality in  
every field**

**TAS**  
**SCHÄFER**



# 3191 Heavy-Range

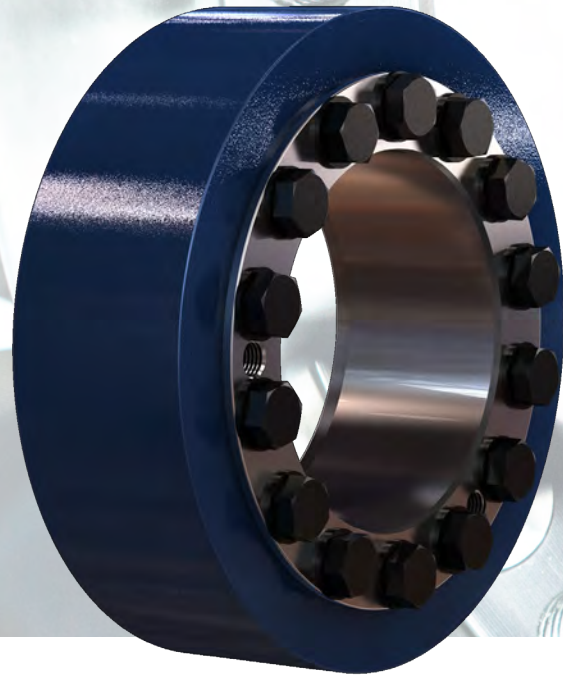
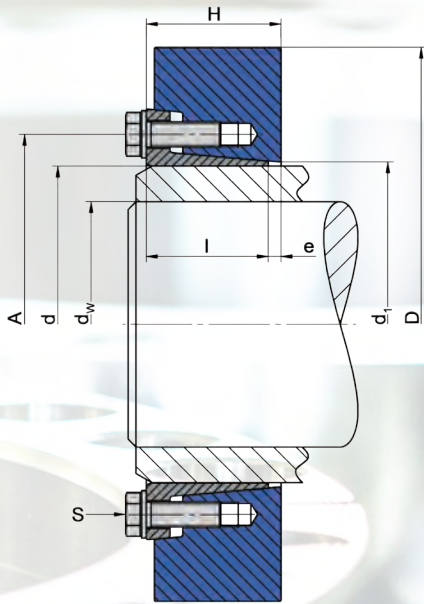

## Used Symbols

$d$	[mm]	Nominal diameter of the shrink disc
$d_w$	[mm]	Shaft diameter
$M_{max}$	[Nm]	Maximal transmittable torque
$D$	[mm]	Outer diameter
$l$	[mm]	Length of the bush
$e$	[mm]	Excess length
$H$	[mm]	Width of the shrink disc
$A$	[mm]	Pitch circle diameter
$d_1$	[mm]	Attachment size
$M_A$	[Nm]	Tightening torque of the clamping screws
$Z$		Number of clamping screws
$S$		Size of the clamping screws
$n_{max}$	[min <sup>-1</sup> ]	Permitted rotational frequency
$p_N$	[N/mm <sup>2</sup> ]	Average pressure to the hub
$I$	[kgm <sup>2</sup> ]	Moment of inertia

## Design of the shrink disc

$d < 120$	Discs lightly oiled without washers
$d \geq 120$	Disc painted with washers
$d \geq 195$	Cone of bush not slit

Dimensions H & e in unlocked position

min. yield strength Rp0,2	N/mm <sup>2</sup>
Solid shaft	290
Hub	350

## Variation from the standard shaft diameter $d_w$

> mm	≤ mm	minimal - mm	maximal + mm
40	50	-3	2
50	140	-5	5
140	180	-10	5
180	320	-15	10
320	440	-20	10
440	600	-30	10

$$M = M_{max (Catalog)} \left( \frac{d_w (target)}{d_w (Catalog)} \right)^2$$

(see Basics - Calculation)

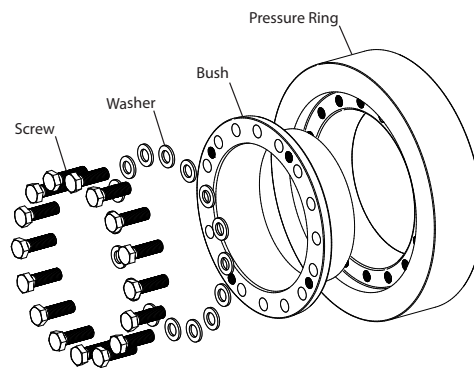

Ordering information: TAS 3191 - d (z.B.: TAS 3191-200 ... further sizes on request)

# 3191 Heavy-Range

<b>d</b> mm	<b>d<sub>w</sub></b> mm	<b>M<sub>max</sub></b> Nm	<b>D</b> mm	<b>l</b> mm	<b>e</b> mm	<b>H</b> mm	<b>A</b> mm	<b>d<sub>1</sub></b> mm	<b>M<sub>A</sub></b> Nm	<b>Z</b> Stk	<b>S</b>	<b>DIN</b>	<b>Class</b>	<b>n<sub>max</sub></b> min <sup>-1</sup>	<b>p<sub>N</sub></b> N/mm <sup>2</sup>	<b>I</b> kgm <sup>2</sup>	<b>Weight</b> kg
110	80	13413	185	65	5	70	139	113	100	10	M 12 x 35	933	12.9	3097	226	0,0508296	8,78
125	90	22621	215	69	6,5	75,5	163	129	250	8	M 16 x 50	933	12.9	2665	291	0,0959929	12,4
135	95	24251	230	69	6,5	75,5	178	144	250	8	M 16 x 50	933	12.9	2491	248	0,1250883	14,1
140	105	30603	230	69	6,5	75,5	178	144	250	8	M 16 x 50	933	12.9	2491	248	0,1278926	14,1
155	115	50510	263	72	9	81	196	159	250	12	M 16 x 50	933	12.9	2179	318	0,2402568	20,6
165	125	62853	290	81	8	89	204	169	250	12	M 16 x 50	933	12.9	1976	285	0,3853659	27,7
175	135	72733	300	81	8	89	214	179	250	12	M 16 x 50	933	12.9	1910	262	0,4359133	28,9
185	145	122608	320	100	12,5	112,5	232	189	480	12	M 20 x 60	933	12.9	1790	310	0,7859084	43,9
200	155	113000	350	102	11	113	246	204	490	14	M 20 x 60	933	10.9	1637	302	1,0778672	53,1
220	165	137000	370	127	9	136	270	225	490	18	M 20 x 60	933	10.9	1549	271	1,5895806	68,6
240	180	180000	405	132	12	144	298	248	490	20	M 20 x 60	933	10.9	1415	260	2,4546318	88,6
260	200	224000	430	148	12	160	326	266	490	22	M 20 x 60	933	10.9	1332	228	3,4273171	109
280	220	305000	460	160	12	172	346	289	840	18	M 24 x 70	933	10.9	1246	241	4,8181962	133
300	240	398000	485	160	16	176	366	305	840	21	M 24 x 70	933	10.9	1181	261	6,0332094	148
320	250	433000	520	170	14	184	388	325	840	22	M 24 x 70	931	10.9	1102	244	8,3297625	179
340	260	460000	570	186	14	200	414	349	1250	18	M 27 x 80	933	10.9	1005	223	13,3704682	243
350	270	494000	570	186	14	200	419	359	1250	18	M 27 x 80	933	10.9	1005	222	12,9280867	231
360	280	576000	590	188	22	210	434	365	1250	20	M 27 x 80	931	10.9	971	235	15,9212399	267
390	300	627000	650	205	15	220	470	398	1250	21	M 27 x 90	931	10.9	881	198	24,8087801	345
420	330	973000	715	222	25	247	508	428	1700	20	M 30 x 80	931	10.9	801	235	41,0007733	477
440	350	1160000	750	233	25	258	528	448	1700	22	M 30 x 90	931	10.9	764	234	51,9773030	550
460	370	1307000	770	240	18	258	548	468	1700	23	M 30 x 90	931	10.9	744	227	57,1634855	568
480	390	1435000	800	270	28	298	572	488	1700	24	M 30 x 90	931	10.9	716	197	76,8838095	707
500	410	1650000	825	270	28	298	592	508	1700	26	M 30 x 90	931	10.9	694	206	86,4231353	743
530	440	2105000	890	306	32	338	640	539	2200	25	M 33 x 100	931	10.9	644	198	133,9516584	999
560	460	2276000	940	306	32	338	670	569	2200	26	M 33 x 100	931	10.9	610	196	166,6476108	1114

# 3193 Heavy-Range (strengthened)

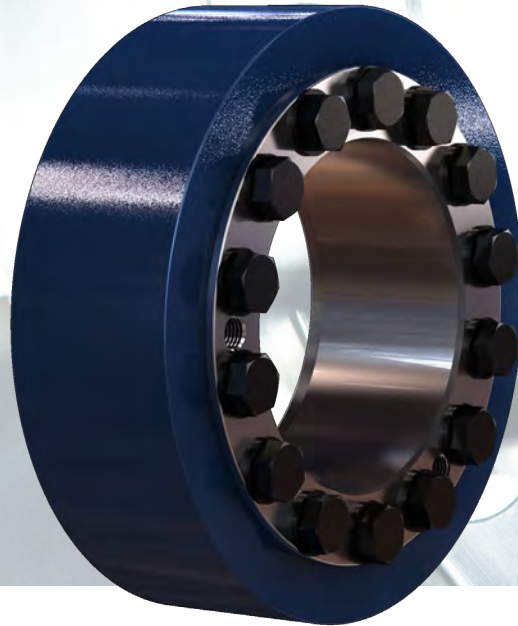
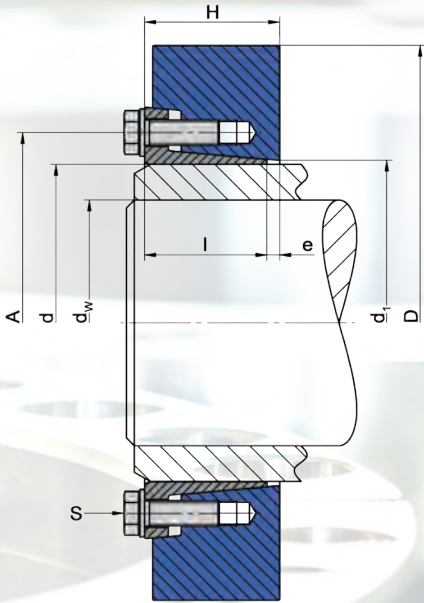

## Used symbols

$d$	[mm]	Nominal diameter of the shrink disc
$d_w$	[mm]	Shaft diameter
$M_{max}$	[mm]	Maximal transmittable torque
$D$	[mm]	Outer diameter
$l$	[mm]	Length of the bush
$e$	[mm]	Excess length
$H$	[mm]	Width of the shrink disc
$A$	[mm]	Pitch circle diameter
$d_1$	[mm]	Attachment size
$M_A$	[Nm]	Tightening torque of the clamping screws
$Z$		Number of clamping screws
$S$		Size of the clamping screws
$n_{max}$	[min <sup>-1</sup> ]	Permitted rotational frequency
$p_N$	[N/mm <sup>2</sup> ]	Average pressure to the hub
$I$	[kgm <sup>2</sup> ]	Moment of inertia

## Design of the shrink disc

$d < 120$	Discs lightly oiled without washers
$d \geq 120$	Disc painted with washers
$d \geq 195$	Cone of bush not slit

Dimensions H & e in unlocked position

min. yield strength Rp0,2	N/mm <sup>2</sup>
Solid shaft	350
Hub	450

## Variation from the standard shaft diameter $d_w$

> mm	≤ mm	minimal - mm	maximal + mm
40	50	-3	2
50	140	-5	5
140	180	-10	5
180	320	-15	10
320	440	-20	10
440	600	-30	10

$$M = M_{max (Catalog)} \left( \frac{d_w (target)}{d_w (Catalog)} \right)^2$$

(see Basics - Calculation)

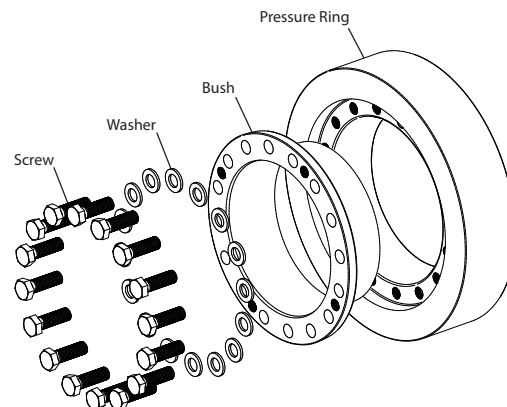

Ordering information: TAS 3193 - d (z.B.: TAS 3193-200 ... further sizes on request)



# 3193 Heavy-Range (strengthened)

<b>d</b> mm	<b>d<sub>w</sub></b> mm	<b>M<sub>max</sub></b> Nm	<b>D</b> mm	<b>l</b> mm	<b>e</b> mm	<b>H</b> mm	<b>A</b> mm	<b>d<sub>1</sub></b> mm	<b>M<sub>A</sub></b> Nm	<b>Z</b> Stk	<b>S</b>	<b>DIN</b>	<b>Class</b>	<b>n<sub>max</sub></b> min <sup>-1</sup>	<b>p<sub>N</sub></b> N/mm <sup>2</sup>	<b>I</b> kgm <sup>2</sup>	<b>Weight</b> kg
110	80	15657	185	65	5	70	139	113	120	10	M 12 x 35	933	12.9	3097	272	0,0508296	8,78
125	90	26187	215	69	6,5	75,5	163	129	290	8	M 16 x 50	933	12.9	2665	337	0,0959929	12,4
135	95	28736	230	69	6,5	75,5	178	144	290	8	M 16 x 50	933	12.9	2491	287	0,1250883	14,1
140	105	35156	230	69	6,5	75,5	178	144	290	8	M 16 x 50	933	12.9	2491	287	0,1278926	14,1
155	115	58406	263	72	9	81	196	159	290	12	M 16 x 50	933	12.9	2179	370	0,2402568	20,6
165	125	71252	290	81	8	89	204	169	290	12	M 16 x 50	933	12.9	1976	330	0,3853659	27,7
175	135	81896	300	81	8	89	214	179	290	12	M 16 x 50	933	12.9	1910	303	0,4359133	28,9
185	145	131546	320	100	12,5	112,5	232	189	570	12	M 20 x 60	933	12.9	1790	368	0,7859084	43,9
200	155	131000	350	102	11	113	246	204	570	14	M 20 x 60	933	12.9	1637	352	1,0778672	53,1
220	165	159000	370	127	9	136	270	225	570	18	M 20 x 60	933	12.9	1549	318	1,5895806	68,6
240	180	209000	405	132	12	144	298	248	570	20	M 20 x 60	933	12.9	1415	305	2,4546318	88,6
260	200	260000	430	150	12	162	326	266	570	22	M 20 x 60	933	12.9	1332	268	3,4273171	109
280	220	354000	460	160	12	172	346	289	980	18	M 24 x 70	933	12.9	1246	283	4,8181962	133
300	240	464000	485	162	16	178	366	305	980	21	M 24 x 70	933	12.9	1181	306	6,0332094	148
320	250	505000	520	170	14	184	388	325	980	22	M 24 x 70	931	12.9	1102	287	8,3297625	179
340	260	536000	570	189	14	203	414	349	1450	18	M 27 x 80	933	12.9	1005	262	13,3704682	243
350	270	576000	570	186	14	200	419	354	1450	18	M 27 x 80	933	12.9	1005	260	12,9280867	231
360	280	671000	590	191	22	213	434	365	1450	20	M 27 x 80	933	12.9	971	276	15,9212399	267
390	300	730000	650	208	15	223	470	398	1450	21	M 27 x 90	931	12.9	881	233	24,8087801	345
420	330	1154000	715	222	25	247	508	428	1950	20	M 30 x 80	931	12.9	801	276	41,0007733	477
440	350	1351000	750	233	25	258	528	448	1950	22	M 30 x 90	931	12.9	764	275	51,9773030	550
460	370	1523000	770	243	18	261	548	468	1950	23	M 30 x 90	931	12.9	744	267	57,1634855	568
480	390	1672000	800	270	28	298	572	488	1950	24	M 30 x 90	931	12.9	716	231	76,8838095	707
500	410	1960000	825	270	28	298	592	508	1950	26	M 30 x 90	931	12.9	694	241	86,4231353	743
530	440	2505000	890	306	32	338	640	539	2600	25	M 33 x 100	931	12.9	644	234	133,9516584	999
560	460	2653000	940	309	32	341	670	569	2600	26	M 33 x 100	931	12.9	610	231	166,6476108	1114