

PPC SERIES

3-Jaw Parallel Grippers | Features and Benefits | How To Order

Features:

- Multipurpose robust gripper with high repeatability
- Through-hole design for 3rd party tooling, imaging, part ejectors, hoses and sensing.
- Spring assist option maintains grip in case of air pressure loss
- Grip force range from 1474N to 4332N
- Repeatability of +/-0.02mm

Applications:

- Feed thru work piece applications
- Optical workpiece inspection via center hole
- Part feed/ejection, part cleaning, part presence



How To Order

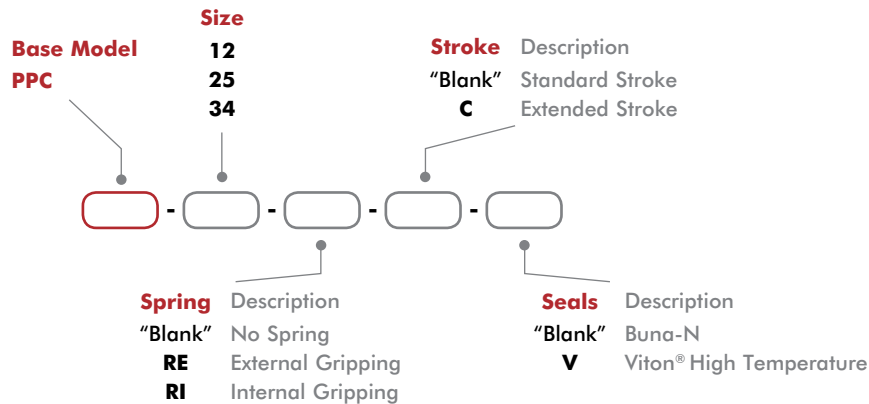

Accessories

Sensor Accessories	Model Numbers	Part Number	Qty/Unit
Inductive Sensor Mounting Kit (1 Holder, 1 Flag, 2 Spacers)	PPC-12	OSMK-105	1-2
Inductive Sensor Mounting Kit (1 Holder, 1 Flag, 2 Spacers)	PPC-25	OSMK-106	1-2
Inductive Sensor Mounting Kit (1 Holder, 1 Flag, 2 Spacers)	PPC-34	OSMK-107	1-2
NPN Inductive Sensor with Quick Disconnect*	All Models	OISP-011	1-4
PNP Inductive Sensor with Quick Disconnect*	All Models	OISP-011	1-4
Quick Disconnect Cable (2 meters long)*	All Models	CABL-010	1-4
Quick Disconnect Cable (5 meters long)*	All Models	CABL-013	1-4

*Sensor and cable sold separately.

3-Jaw Parallel Grippers | Technical Specifications

Specifications	Units	12	12-C	25	25-C
Total Rated Grip Force F @ 100 psi [7 bar]*	N [lbs]	1474 [331]	896 [201]	2620 [589]	1642 [369]
Total Stroke	mm [in]	10 [0.394]	16 [0.630]	13 [0.512]	20 [0.787]
Weight	kg [lbs]	1.0 [2.2]	1.1 [2.4]	2.2 [4.9]	2.3 [5.1]
Pressure Range (without spring)	bar [psi]	2-7 [30-100]			
Pressure Range (with spring)	bar [psi]	3-7 [45-100]			
Ingress Protection Class (IP)		IP54			
Displacement	cm ³ [in ³]	23 [1.40]		51 [3.11]	
Temperature Range (Buna-N seals)	°C [°F]	-35°~80° [-30°~180°]			
Temperature Range (Viton® seals)	°C [°F]	-30°~150° [-20°~300°]			
Actuation	sec.	0.03		0.04	
Repeatability	mm [in]	±0.02 [±0.0008]			

*With springs

Specifications	Units	34	34-C
Total Rated Grip Force F @ 100 psi [7 bar]*	N [lbs]	4332 [974]	2938 [638]
Total Stroke	mm [in]	20 [0.787]	30 [1.181]
Weight	kg [lbs]	5.1 [11.2]	5.3 [11.7]
Pressure Range (without spring)	bar [psi]	2-7 [30-100]	
Pressure Range (with spring)	bar [psi]	3-7 [45-100]	
Ingress Protection Class (IP)		IP54	
Displacement	cm ³ [in ³]	128 [7.81]	
Temperature Range (Buna-N seals)	°C [°F]	-35°~80° [-30°~180°]	
Temperature Range (Viton® seals)	°C [°F]	-30°~150° [-20°~300°]	
Actuation	sec.	0.06	
Repeatability	mm [in]	±0.02 [±0.0008]	

*With springs

PPC-12, -12-C

3-Jaw Parallel Grippers | Dimensions and Technical Specifications

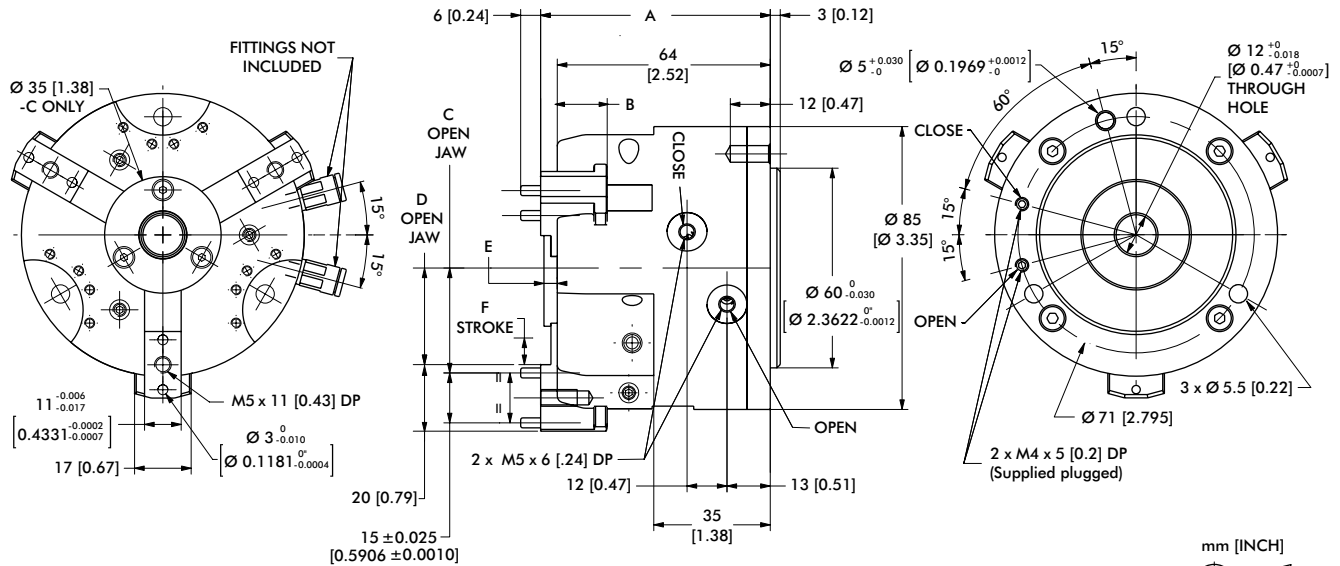
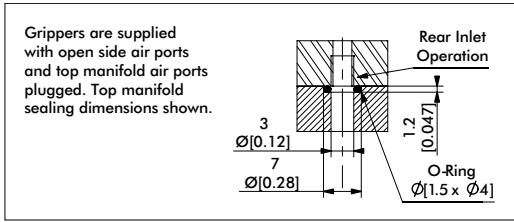

Model	A	B	C	D	E	F
PPC-12	65 [2.56]	64 [2.52]	25.5 [1.004]	23 [0.906]	--	5 [0.2]
PPC-12-C	69 [2.72]	64 [2.52]	31.5 [1.241]	29.03 [1.143]	4 [0.16]	8 [0.31]

Dimensions in mm [in]

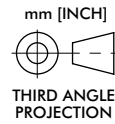

Loading Information

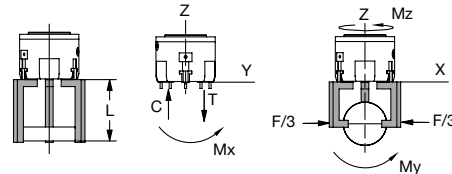
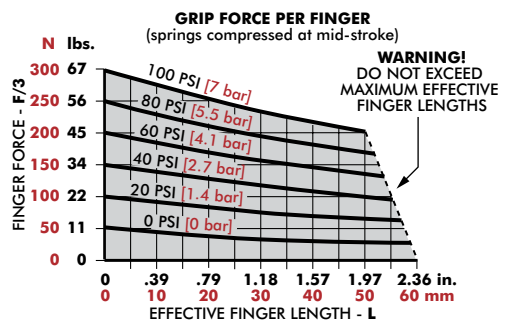
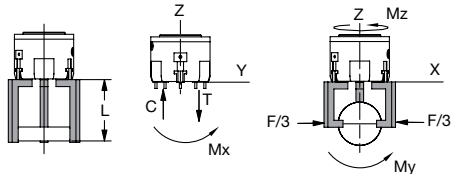
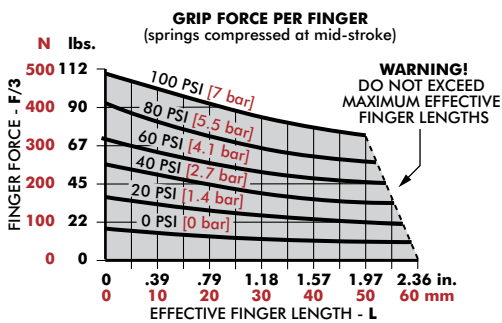

PPC-12	Static	Dynamic
Maximum Tensile T	850 N [191 lbs]	220 N [49 lbs]
Maximum Compressive C	1150 N [259 lbs]	220 N [49 lbs]
Maximum Moment M_x	20 Nm [177 in-lbs]	6 Nm [53 in-lbs]
Maximum Moment M_y	20 Nm [177 in-lbs]	6 Nm [53 in-lbs]
Maximum Moment M_z	50 Nm [443 in-lbs]	10 Nm [89 in-lbs]

*Capacities are per set of jaws and are not simultaneous

PPC-12-C	Static	Dynamic
Maximum Tensile T	[214 lbs] 950 N	220 N [49 lbs]
Maximum Compressive C	[281 in-lbs] 1250 N	220 N [49 lbs]
Maximum Moment M_x	[177 in-lbs] 20 Nm	6 Nm [53 in-lbs]
Maximum Moment M_y	[177 in-lbs] 20 Nm	6 Nm [53 in-lbs]
Maximum Moment M_z	[531 in-lbs] 60 Nm	10 Nm [89 in-lbs]

*Capacities are per set of jaws and are not simultaneous

3-Jaw Parallel Grippers | Dimensions and Technical Specifications

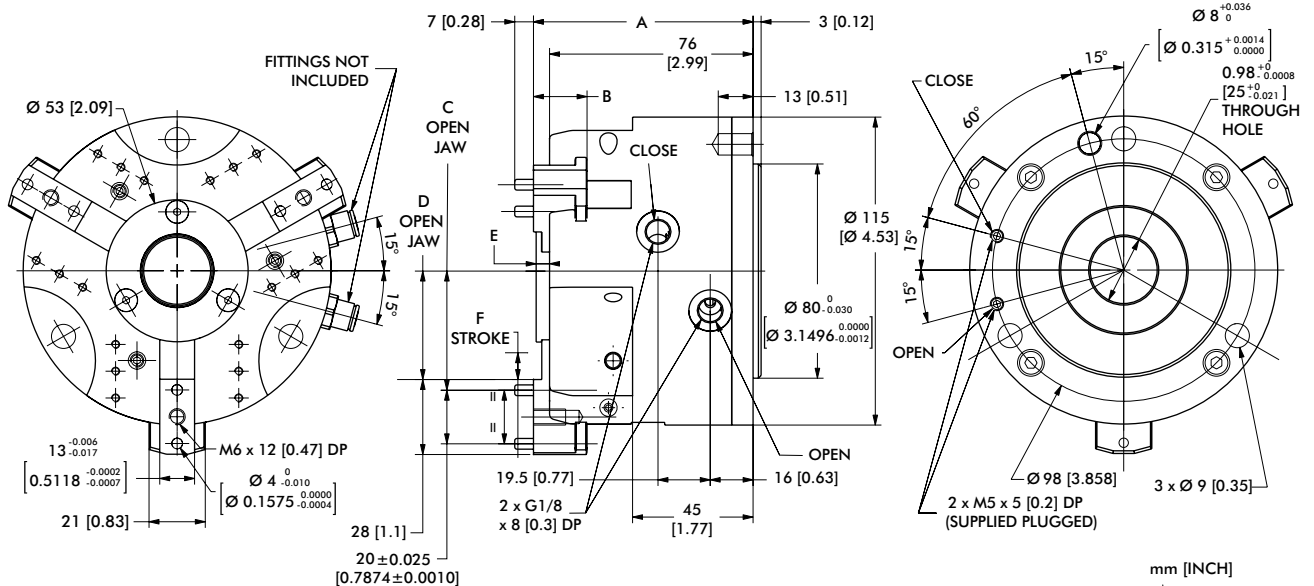
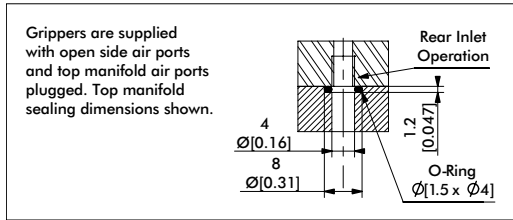

Model	A	B	C	D	E	F
PPC-25	77 [3.03]	76 [2.99]	37.5 [1.476]	33.5 [1.319]	--	6.5 [0.26]
PPC-25-C	82 [3.23]	76 [2.99]	44.5 [1.792]	40.5 [1.594]	5 [0.2]	10 [0.39]

Dimensions in mm [in]

Loading Information

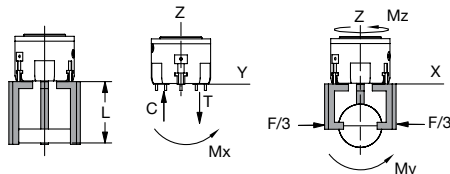
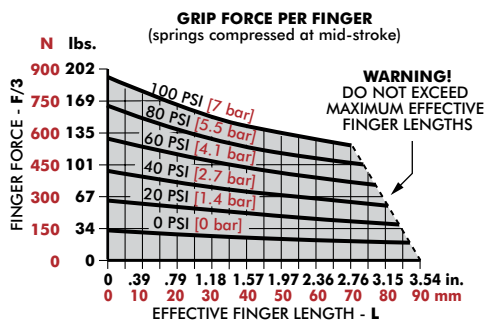

	Static	Dynamic
Maximum Tensile T	1300 N [292 lbs]	390 N [88 lbs]
Maximum Compressive C	1500 N [337 lbs]	390 N [88 lbs]
Maximum Moment M_x	30 Nm [266 in-lbs]	13 Nm [115 in-lbs]
Maximum Moment M_y	30 Nm [266 in-lbs]	13 Nm [115 in-lbs]
Maximum Moment M_z	65 Nm [575 in-lbs]	25 Nm [221 in-lbs]

*Capacities are per set of jaws and are not simultaneous

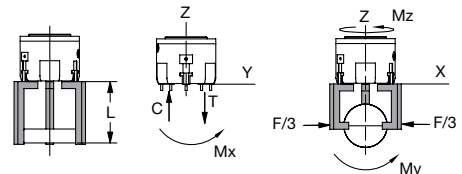
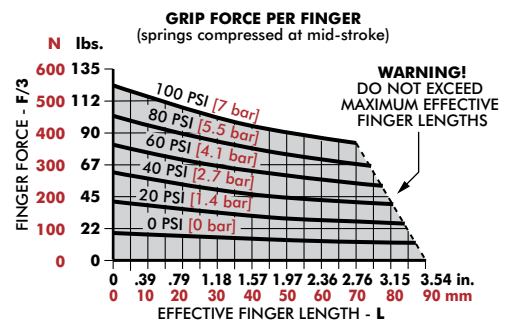

	Static	Dynamic
Maximum Tensile T	1300 N [292 lbs]	390 N [88 lbs]
Maximum Compressive C	1500 N [337 lbs]	390 N [88 lbs]
Maximum Moment M_x	30 Nm [266 in-lbs]	13 Nm [115 in-lbs]
Maximum Moment M_y	30 Nm [266 in-lbs]	13 Nm [115 in-lbs]
Maximum Moment M_z	70 Nm [620 in-lbs]	25 Nm [221 in-lbs]

*Capacities are per set of jaws and are not simultaneous

PPC-34, -34-C

3-Jaw Parallel Grippers | Dimensions and Technical Specifications

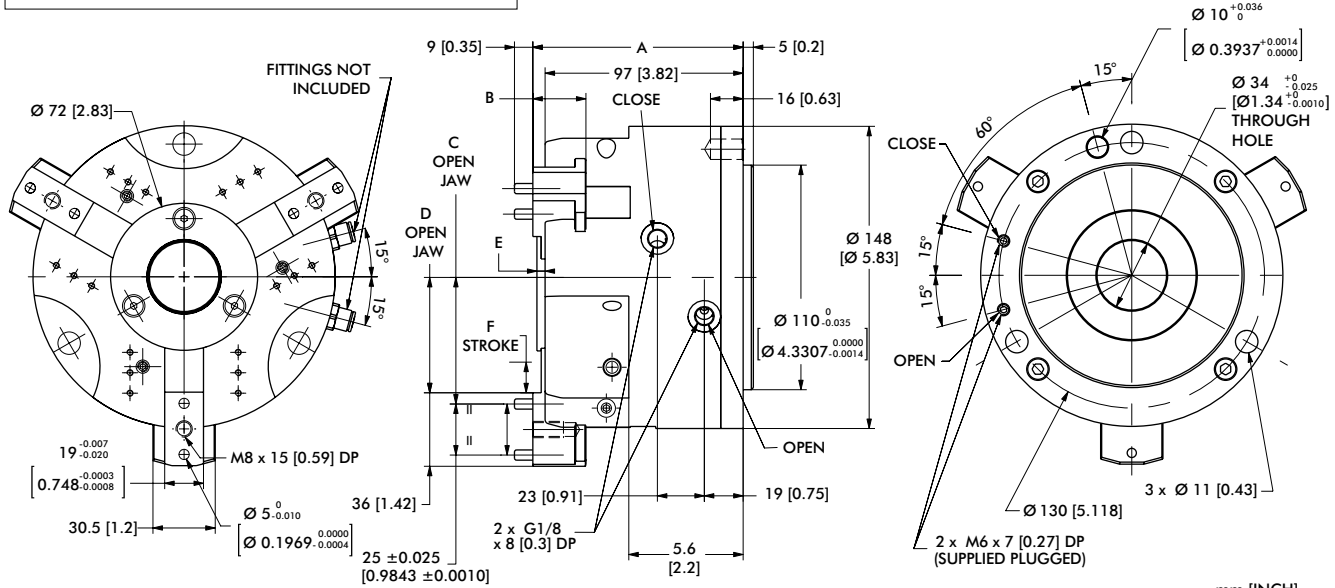
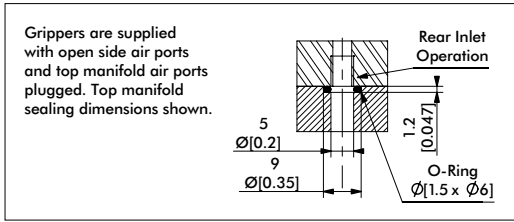

Model	A	B	C	D	E	F
PPC-34	98 [3.86]	97 [3.82]	52 [2.047]	46.5 [1.831]	--	10 [0.39]
PPC-34-C	103 [4.06]	97 [3.82]	62 [2.441]	56.5 [2.224]	4 [0.16]	15 [0.59]

Dimensions in mm [in]

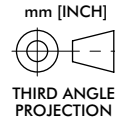

Loading Information

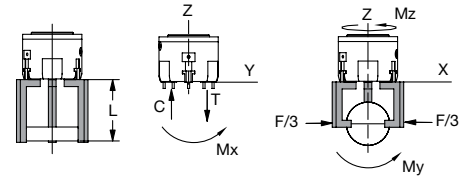
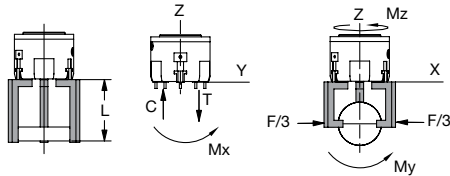
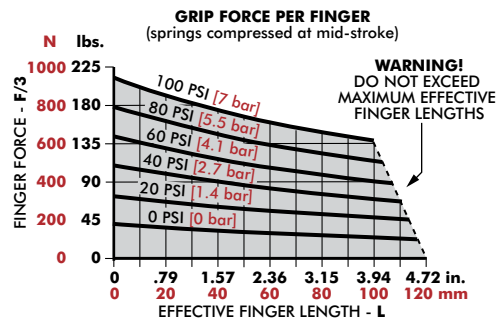
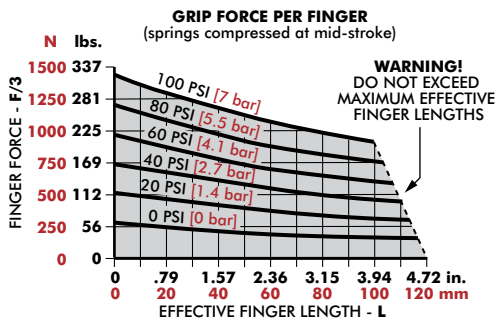

PPC-34	Static	Dynamic
Maximum Tensile T	1950 N [438 lbs]	650 N [146 lbs]
Maximum Compressive C	2150 N [483 lbs]	650 N [146 lbs]
Maximum Moment M_x	65 Nm [575 in-lbs]	32 Nm [283 in-lbs]
Maximum Moment M_y	65 Nm [575 in-lbs]	32 Nm [283 in-lbs]
Maximum Moment M_x	100 Nm [885 in-lbs]	55 Nm [487 in-lbs]

*Capacities are per set of jaws and are not simultaneous

PPC-34-C	Static	Dynamic
Maximum Tensile T	2150 N [438 lbs]	650 N [146 lbs]
Maximum Compressive C	2350 N [528 lbs]	650 N [146 lbs]
Maximum Moment M_x	65 Nm [575 in-lbs]	32 Nm [283 in-lbs]
Maximum Moment M_y	65 Nm [575 in-lbs]	32 Nm [283 in-lbs]
Maximum Moment M_x	120 Nm [1062 in-lbs]	55 Nm [487 in-lbs]

*Capacities are per set of jaws and are not simultaneous